

VALKENPOWER



User Manual Petrol Generator Type EC7000NE



Read this manual carefully before using the generator.

Table of contents	Page
1. Safety & Risk Prevention	
1.1 Warnings	4
1.2 Safety instructions	5
1.3 Symbols	6 - 7
1.4 General information	8
2. Use before starting	
2.1 Scope of application	9
2.2 Pre-use Inspection	10
2.2.1 Fuel level	10
2.2.2 Filling and checking engine oil	10
2.2.3 Installing the battery	10
3. Operating the appliance	
3.1 Starting the engine	11
3.2 3-pins ATS uitgang (Automatic Transfer Switch)	12
3.3 Switching off the engine	13
4. Maintenance & service	
4.1 Maintenance	14
4.2 Changing engine oil	15
4.3 Air filter maintenance	15
4.4 Spark plug maintenance	16
4.5 Fuel Filter Head Maintenance	16
5. Transport and storage	
5.1 Transport	17
5.2 Lookup	17
6. Troubleshooting & Technical Data	
6.1 Troubleshooting	18
6.2 Specifications	19
6.3 Parts	20
6.4 Parts list	20
6.5 Mounting the Wheels	21
7. Panel & Schematics	
7.1 Control panel	22
7.2 Wiring diagram	22
8. Official documents	
8.1 Warranty	23
8.2 EC declaration	24

Keeping the user manual

- Please keep this manual in a safe place. The information in this document may be necessary for Installation, use, maintenance, or troubleshooting. Keep this manual accessible for future reference. This user manual contains important safety instructions and legal information. Retain this document for the entire life of the product. Always provide this manual if the product is resold, transferred, or relocated. It is mandatory to keep this user manual in a centrally accessible location. Employees who work with this product must have access to the most recent version of this documentation at all times.
-



Dispose of electrical appliances in an environmentally friendly manner. Do not dispose of electrical appliances with household waste. In accordance with European Directive 2012/19/EU on electronic appliances, they must be collected separately for recycling. Contact your local authorities for available disposal options for your worn-out appliance.

© 2025 Valkenpower All rights reserved. No part of this publication may be reproduced, stored in a retrieval system, or published in any form or by any means without the express prior written permission of the publisher, except in cases where legally permitted.

1.1 Warning

- When connecting the generator to your home's electrical system, make sure this is done by a qualified electrician. An incorrect connection between the generator and the loads can cause damage, burns, or fire to the generator.
- Place the generator at least 1 meter away from buildings or other equipment during use.
- Never use the generator when it is hanging or tilted. The generator should only be used and stored in an upright position.
- Make sure you can turn off the generator quickly and know how to operate it.
- Keep away from cigarettes, smoke, hot objects and sparks when refueling.
- Always refuel in a well-ventilated area and when the engine is switched off.
- Gasoline is extremely flammable and explosive under certain conditions.
- Wipe up any spilled gasoline immediately.
- Improper use of the generator may result in electric shock; never use the generator with wet hands.
- Never use the generator in rain or snow and do not let it get wet.
- Disconnect all connected equipment before starting or stopping the generator to prevent equipment damage.
- Engine exhaust fumes are toxic. The generator should only be used outdoors.
- Protection against electrocution depends on fuses specifically designed for the generator. When a fuse needs to be replaced, the replacement fuse must have the same properties and performance characteristics as the fuse being replaced.
- Due to the high mechanical stresses, only use an extension cord that meets national requirements.
- When using extension cords or mobile distribution networks, a line with a cross-section of 1.5 mm² may not exceed 60 meters. A line with a cross-section of 2.5 mm² has a maximum length of 100 meters.
- Before starting the generator, make sure there are no loose tools and/or materials on the generator.
- To prevent electrical interference, you must ground the gasoline generator set.

1.2 Safety instructions

- Read all instructions in this manual carefully before using the product.
- Always follow indicated procedures and warning symbols.
- Use the product only for the purpose for which it was designed.
- Wear appropriate personal protective equipment where applicable.
- Never operate the product under the influence of alcohol, drugs or medications that reduce alertness.
- Do not allow persons lacking sufficient knowledge or experience to operate the product unless they are supervised by a competent person.
- Never make any adjustments or modifications not specified in the manual.
- Keep hands and other parts of the body away from moving, hot or pressurized parts.
- Use the product only in a clean, dry and well-lit environment.
- Ensure adequate ventilation during use.
- Keep the work area clear of obstacles and loose objects.
- Keep children and unauthorized persons away from the work area.
- Check that the supply voltage matches the product specifications.
- Use only original replacement parts.
- Turn off the product and disconnect it from the power or pressure source before making any adjustments, cleaning, or repairs.
- Have defects repaired only by an authorized technician.
- Stop use immediately if you notice any abnormal noise, odor, or vibration.
- Switch off the product immediately in the event of malfunctions or dangerous situations.
- Always ensure that a suitable fire extinguisher and first aid kit are nearby.
- Do not use electrical equipment in damp or wet environments, do not expose it to rain, and do not use it near flammable liquids or gases.
- When not in use, tools should be stored out of reach.
- Keep tool handles dry, clean and free from grease and oil.
- For outdoor use only due to risk of suffocation.

1.3 Symbols label



Before use: Read the instructions carefully.



Before use: Check the oil and fuel levels.



Fuel-related: Refueling / Cap closure / OFF position..



Do not use in closed spaces.
1. Do not use inside a house/closed space.



Exhaust fumes contain poisonous carbon monoxide.
Avoid inhalation.



Hot surface - May cause burns.

1.3 Symbols label



Complies with the European emission standard Euro V.



Hearing protection required.



Fire hazard (petrol flammable).



Electrical voltage / shock hazard.



Prohibited: No smoking / no open fires.

1.4 General information

- Before using this machine, you must first read and understand the operating instructions in full! This manual contains important information for the correct installation, operation, and maintenance of the equipment described herein. Using any generator involves various risks of personal injury or property damage. Anyone involved with the installation, maintenance, or operation of the generator must be fully familiar with the contents of this manual. To protect yourself from personal injury or property damage, you must follow the directions and instructions in this manual. Every Valkenpower generator is manufactured in accordance with the Machinery Directive 2006/42/CE. A manual, including a Declaration of Conformity, is supplied with every generator. This manual should be kept and maintained. Because quality is constantly being improved, Valkenpower b.v. reserves the right to change the specifications of the equipment described in this manual.

General safety instructions for power tools

To use this product correctly, you must be familiar with the safety regulations, assembly instructions, and operating instructions as described in this user manual. Anyone who uses or operates the appliance must be familiar with this manual and informed of any potential risks. Children and people with health problems must not use this appliance. Children must be supervised at all times when they are near the appliance. It is absolutely essential that you observe the safety regulations to prevent accidents. The same applies to regulations regarding health and safety at work.

Warning:

Prevent the risk of fire, electric shock, and personal injury when using the generator. Always follow the safety instructions in this manual.



Warning:

When connecting a generator to the mains supply at home, this must be done by a qualified electrician in accordance with NEN 1010 (safety regulations for low-voltage installations) and NEN 3140 (safe working on and with electrical installations).

An incorrect or unapproved connection between the generator and the home installation can cause serious injury, electric shock, fire and permanent damage to the generator and the installation.

2.1 Scope of application

The following table provides reference information for connecting electrical appliances to the generator.

Description	Wattage		peak load	
	assets	powerfactor	startup peak	continuous power assessment
	1000	x1	1000	1000
	1000	x1.5	1500	1000
	1000	x2	2000	1000

NOTIFICATION:

- Both AC and DC inputs can be used simultaneously, and the total output power cannot exceed the rated output power. When the total output power exceeds the rated output, the overload indicator light will illuminate.

Generator power

Nominal power of the generator AC	7000W
Peak power AC	7500W

NOTICE: Do not overload. The total wattage of the electrical equipment must not exceed Do not exceed the generator output power, otherwise the generator will be damaged. When using this generator to power precision instruments, electronic controllers, personal computers, electronic computers, microcomputers, etc., maintain sufficient distance between the equipment and the generator to prevent electromagnetic interference from the motor. This also ensures that the motor is shielded from surrounding electronics. If this generator is used to power medical equipment, it is recommended to consult the equipment manufacturer, professional, or hospital regarding the amount of current required to start certain electronic equipment or general motors, which may render them unusable. Even if the start-up parameters meet the conditions in the table above, you should still contact the equipment manufacturer.

2.2 Pre-use Inspection

⚠ Warning: The engine and exhaust become very hot during use. Check that Do not repair them until they have cooled sufficiently. Prevent any part of your body or clothing from coming into contact with the engine or exhaust.

2.2.1 Fuel level

DANGER: Do not overfill, or the tank will overflow when it warms up. After filling, make sure the cap is securely tightened.

1. Open the fuel filler cap.
2. Add fuel up to the shoulder of the filter.
3. Check the fuel level and top up if necessary.
4. Replace the fuel filler cap properly

NOTICE: After refueling, wipe off any remaining gasoline promptly with a clean, soft cloth to prevent damage to the plastic casing. Unleaded gasoline must be used. Leaded gasoline can severely damage internal engine components. Remove the fuel cap and add the maximum amount of gasoline to the fuel tank.

Full tank capacity: 43L

2.2.2 Filling and checking engine oil

NOTE: This generator is supplied without oil. Do not start the engine until it is sufficiently filled with oil.

1. Unscrew the oil filler cap and clean the dipstick with a clear cloth.
2. Reinsert the dipstick into the oil filler opening and turn it out to check the oil level.
3. If the oil level is below the lower mark on the dipstick, add oil up to the upper mark on the dipstick.
4. Replace the oil filler cap properly.

Recommended oil: SAE 15W-40

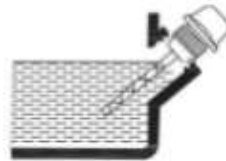

2.2.3 Installing the battery

Install the battery as follows:

Mount the battery with nuts, bolts and washers.

1. Connect the jumper cable only to the starter motor connector at the bottom of the fuel tank.
2. Connect the ground wire to the line at the rear of the generator.
3. First connect the jumper cable to the positive terminal of the battery and then to the negative terminal.
4. Disconnect in reverse order.



1. Control Panel Assy
2. Starter motor
3. Positive wire
4. Battery (with a capacity of 12V-35Ah)
5. Negative wire
6. Holding frame

3.1 Starting the engine

Before starting the engine, ensure the oil pan is filled to the correct level. NOTE: The generator is not factory-primed; you must top up the oil yourself before using it for the first time.

The generator is equipped with an automatic choke. This means the air supply is automatically regulated during starting. When starting from cold, the choke is automatically activated to ease starting. As the engine warms up, the choke gradually deactivates.

The generator is equipped with an electric starting system, a wireless remote control, and a pull cord. This allows the generator to be started and stopped both locally (at the control panel) and remotely.

A) Starting procedure (local):

1. **Check oil and fuel levels.**
2. Turn the fuel valve to the OPEN position.
3. Press the START button to the ON/START position.
4. Release the switch once the engine is running.

Note: Do not turn the ignition switch more than 5 times in a row. If starting fails, release the ignition switch to cool down. Then try starting again after 5 minutes.

B) Remote start:

1. **Make sure the generator is ready for operation (fuel tap open, battery connected).**
2. Press the START button on the remote control.
3. The starter motor is activated and the generator starts automatically.

C) Starting procedure with pull cord:

Remove all loads from the AC outlet.

1. **Turn off the AC breaker.**
2. **Open the fuel tap.**
3. **Move the choke lever to the OFF position.**
4. **Turn on the ignition switch.**
5. **Gently pull the drawstring until you feel a resistance, then pull it up firmly.**
6. **Once the engine has warmed up, move the choke lever to the ON position.**

Warning

After starting, release the starter handle slightly to avoid injury to persons or damage to equipment from rebound.

3.2 3-pins ATS uitgang (Automatic Transfer Switch)

Purpose of the ATS connection

The 3-pin ATS connector is intended for connecting an external ATS/auto-start controller for:

- 12V power supply for the ATS control
- Start signal to the generator



Important (gasoline): The 12V power comes from the generator battery. The ATS box taps into this 12V via the ATS cable and uses it to activate the start signal.

Operation in brief

- The ATS receives +12V and GND from the generator/battery.
- In case of power failure, the ATS gives a start command (start line is connected to +12V).
- When mains power returns, the ATS switches back the load and automatically stops the generator after a short run-on time (no load).
- For gasoline, the “electric door lock” switch on the ATS box must be set to ON.

Connection logic (3 pins)

This 3-pin connector functionally contains:

- GND (12V-)
- +12V (van generatoraccu)
- START (connected to +12V by ATS when starting)

Warning:

- The connection and commissioning of an ATS system may only be carried out by an authorised and recognised electrical installation company.
- An ATS system operates at hazardous voltages and, if incorrectly installed or adjusted, can result in: electrocution; fire or short circuit; damage to the generator; the ATS or connected equipment; backfeeding to the mains, posing a risk to the lives of technicians; and simultaneous switching on of the mains and generator, resulting in serious damage/hazard.
- The installer is responsible for correct connection, protection, earthing/PE, cable cross-sections, selectivity, and performing checks and measurements in accordance with applicable standards and regulations.

3.3 Switching off the engine

A) Local shutdown

Switch off all connected devices or unplug them from the socket. This prevents voltage spikes and motor wear.

1. Set the AC circuit breaker to OFF.
2. Turn the fuel valve to OFF and use the fuel in the carburetor to stop the generator.
3. Press the STOP button.

B) Remote shutdown

1. Press the STOP button on the remote control.
2. The engine is switched off in a controlled manner.

4.1 Maintenance

Proper maintenance is the best guarantee for safe, economical, and trouble-free operation. It also contributes to environmental protection. The user must operate the machine safely. Periodic inspection, adjustment, and lubrication can ensure safe and efficient operation of the generator.

Note: Original parts must be used for replacement.

For more details, please contact your point of sale.

Component	Action	Usage	10 hours	Usage — 50 hours	Every 6 months or 100 hours	Every year or 300 hours
engine oil	check	X		X		
air filter	replace		X(1)		X(1)	
air filter	replace	X		X(1,2)		
spark plug	clean & adjust				X	
spark arrester	clean				X	
float bowl	clean				X	
valve clearance	check & adjust				X(3)	
fuel tank & filter	check				X(3)	
brandstoftank & filter	check				X(3)	X(3)

Warning:

Stop the engine before performing any maintenance work. The engine must be placed in a horizontal position, and the spark plug cap must be separated from the spark plug to prevent the engine from starting. Do not use indoors or in poorly ventilated areas, such as tunnels and caves. Ensure the work area is well ventilated. Engine exhaust fumes contain poisonous carbon monoxide, which, if inhaled, can cause shock, unconsciousness, and even death.

4.2 Changing engine oil

⚠ Warning: Do not drain the oil immediately after the generator is turned off. The oil temperature is still very high. Use caution during operation to avoid burns.

1. Turn and remove the dipstick.
2. Loosen the drain plug and drain the engine oil from the crankcase.
3. Screw on the drain plug.
4. Fill the engine oil to the upper level mark on the dipstick.
5. Place the dipstick in its original position.



Recommended engine oil: SAE 15W40

Note: Do not tilt the engine while adding oil to prevent excess oil from affecting the engine's performance. Ensure that no foreign objects enter the engine housing.

4.3 Air filter maintenance

1. Turn the screw to the left and remove the air filter cover.
2. Check and ensure the air filter element is intact and clean. If it's damaged, replace it with a new one.
3. If the core is dirty, clean it with the appropriate cleaning solvent.
4. Place the filter element in its original position, install the air filter cover and turn the screw clockwise.

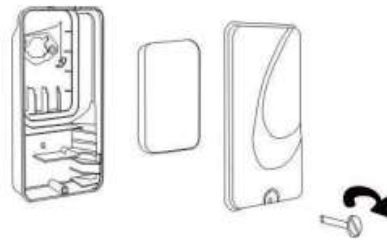
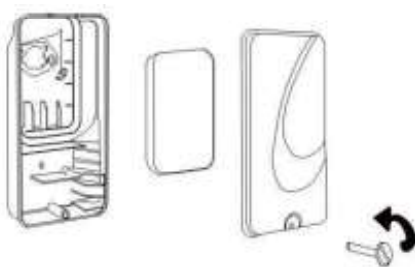

⚠ Warning

Do not use oil to clean the air filter subassembly. Note: Prevent dirt and dust from entering the dust chamber. If dust falls into an engine, it will shorten its lifespan.

4.4 Spark plug maintenance

Spark plugs are an important part of the generator and should be checked regularly

1. Remove the spark plug cap in front of the spark plug.
2. Remove the spark plug using special tools.
3. Remove carbon contamination from around the spark plug.
4. Check the spark plug gap and adjust it if necessary. The gap should be 0.7–0.8 mm.
5. Replace the spark plug and cap properly. Recommended spark plug: F6RTC.

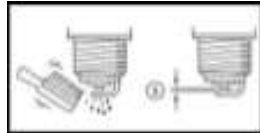
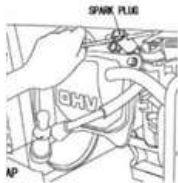

4.5 Fuel Filter Head Maintenance

1. Turn the fuel valve to the OFF position.
2. Unscrew the fuel filter cup and remove it together with the gauze (filter screen).
3. Clean the mesh with clean fuel or compressed air.
4. Check the fuel filter cup for dirt or damage. (Replace parts if necessary.)
5. Place the gauze back into the fuel filter cup in its original position.
6. Install the fuel filter cup with the gauze back onto the fuel filter head and tighten it hand tight.
7. Turn the fuel valve back ON and check for leaks.

5.1 Transport

When transporting the generator, turn the engine switch and fuel valve OFF and keep the generator level to prevent fuel spillage. Fuel vapors or spilled fuel can ignite. If the generator has been used, allow it to cool for at least 15 minutes before loading it into the transport vehicle. Residual exhaust gases can cause burns or accidents.

5.2 Lookup

If you plan to store this generator for an extended period of time, some storage precautions should be taken to prevent aging.

1. Drain the fuel sediment cup.
2. Replace the lock washer and tighten the sediment cup.
3. Turn the fuel valve ON and drain the fuel from the fuel tank.
4. Loosen the carburetor cap screw and drain the gasoline from the carburetor.
5. Remove the oil drain plug, drain the oil, and replace the oil drain plug.
6. Ensure that the storage area is free from excessive moisture and dust.

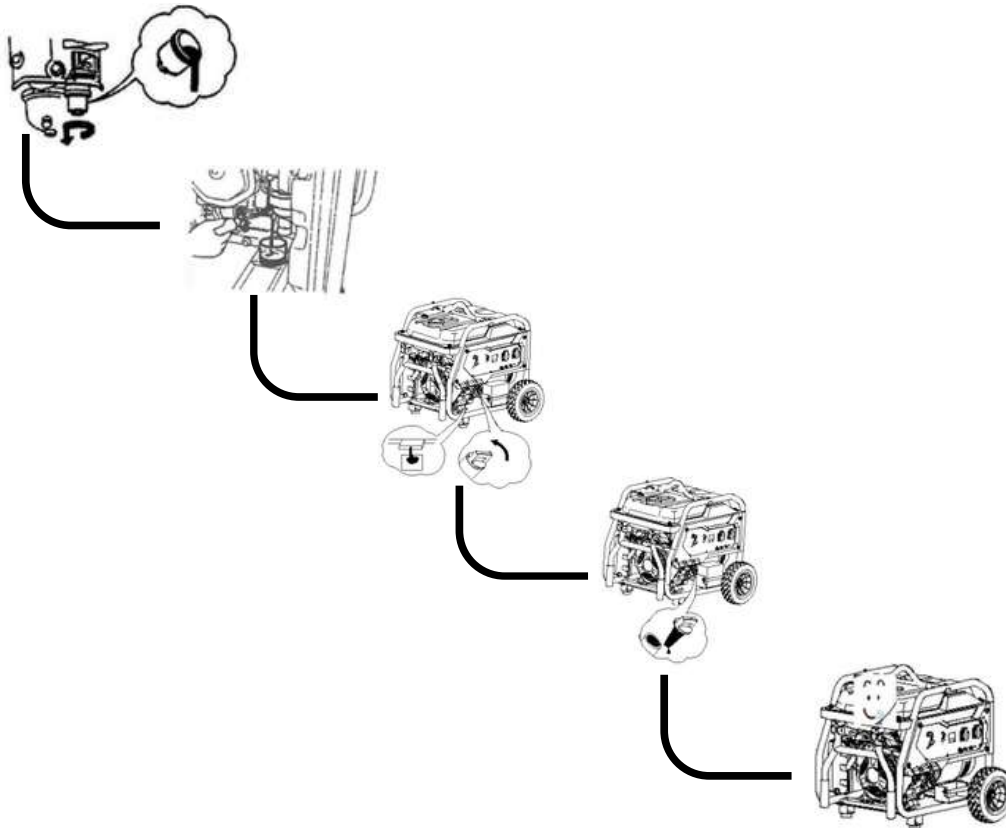

6.1 Troubleshooting

1. Problem: The generator will not start.

- check the engine oil level.
- check the fuel level in the tank.



- check the spark plug and see if it sparks properly.

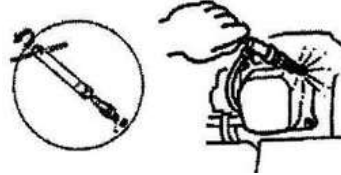

If the generator set still does not work, consult your dealer for assistance.

1. Problem: The appliance cannot generate electricity.

- Check if the AC breaker is turned "ON".

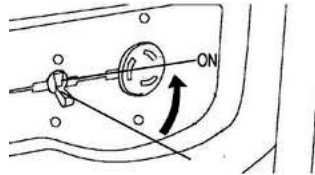

If this check does not work, please consult your point of sale for assistance.

6.2 Specifications

Max. Power	7.5 kW
Max. Power (230V)	7.5 kW
Rated Power (230V)	7 kW
Frequency	50 Hz
Output Voltage	230V
AC Output	230V / 16A (2-pole) - 230V / 32A (3-pole)
AVR	Yes
Engine	KP460E
Model	4-stroke, V-cylinder, OHV (overhead valve)
Engine Type	3600 rpm
Engine Speed	1
Number of Cylinders	459 ml
Cylinder Capacity	Air
Cooling System	cooled
Starting System	Electric Petrol
Fuel Type Tank	35L
Capacity Fuel Consumption at 50% Load	2 L/h
Fuel Consumption at 100% Load	1.1 L/h
Oil Type	O15W40
Oil Capacity	1.4L
Noise Level	76dB

Generatorset

L x W x H / mm	735*570*635
Gross weight / kg	92

6.3 Parts

1. Fuel filler cap
2. AC power outlet
3. AC breaker
4. Voltmeter
5. Dipstick
6. Ignition switch
7. Drain plug
8. Startgreep
9. Fuel switch
10. Air purifier
11. Choke lever
12. DC breaker
13. DC connection
14. Earth connection
15. Exhaust Choke Lever
16. Bougie
17. Fuel sensor

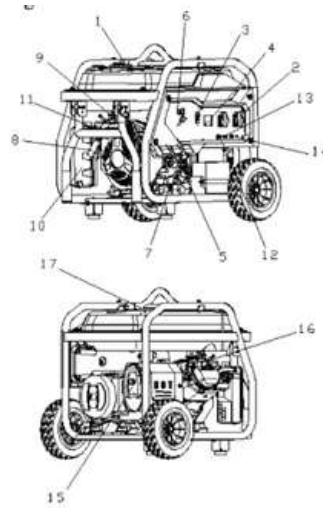

6.4 Parts list

- | | | |
|-----|--------------|---------------------|
| 1. | PEC7000NE-01 | Brandstofvuldop |
| 2. | PEC7000NE-02 | AC power outlet |
| 3. | PEC7000NE-03 | AC breaker |
| 4. | PEC7000NE-04 | Voltmeter |
| 5. | PEC7000NE-05 | Dipstick |
| 6. | PEC7000NE-06 | Ignition switch |
| 7. | PEC7000NE-07 | Drain plug |
| 8. | PEC7000NE-08 | Startgreep |
| 9. | PEC7000NE-09 | Fuel switch |
| 10. | PEC7000NE-10 | Air Purifier |
| 11. | PEC7000NE-11 | Choke lever |
| 12. | PEC7000NE-12 | DC breaker |
| 13. | PEC7000NE-13 | DC connector |
| 14. | PEC7000NE-14 | Ground connection |
| 15. | PEC7000NE-15 | Exhaust Choke Lever |
| 16. | PEC7000NE-16 | Bougie |
| 17. | PEC7000NE-17 | Brandstofsensor |

6.5 Mounting the wheels

Note: Place the generator on a stable, level surface and support it with suitable blocks or lifting tools to ensure the unit is secure and to allow sufficient clearance for mounting the wheels.

1. Mount the wheel onto the axle and then secure it with the nut and split pin.
2. Mount the assembled axle to the frame with bolt and nut.

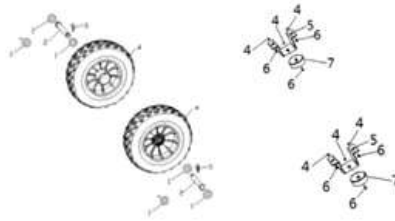

1. Plain washer
2. Wheel axle
3. Spilled pen
4. Wheel
5. Footrest support
6. Bolt M6 x 12
7. Cushion, Frame

Check that:

- All nuts and bolts are securely tightened
- The wheels are mounted stably
- The generator is upright and stable
- Carefully place the generator upright (if tilted) and test moving it.

Warning:

- Do not operate the generator without the wheels properly installed.
- Do not move the generator unless it is switched off.
- Pull or push the generator slowly and in a controlled manner.
- Do not use the generator on sloping or unstable surfaces.

7.1 Control panel

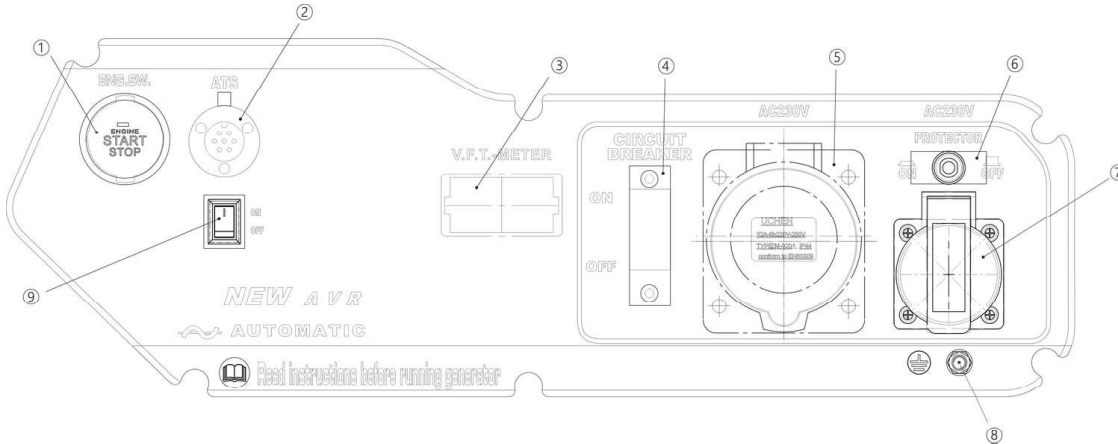

1. Engine start/stop button
2. ATS connection
3. Volt frequency timer
4. Automatic fuse / circuit breaker
5. AC 230V socket
6. AC 230V protector
7. DC 12V connection
8. Earth connection
9. On/off switch

7.2 Wiring diagram

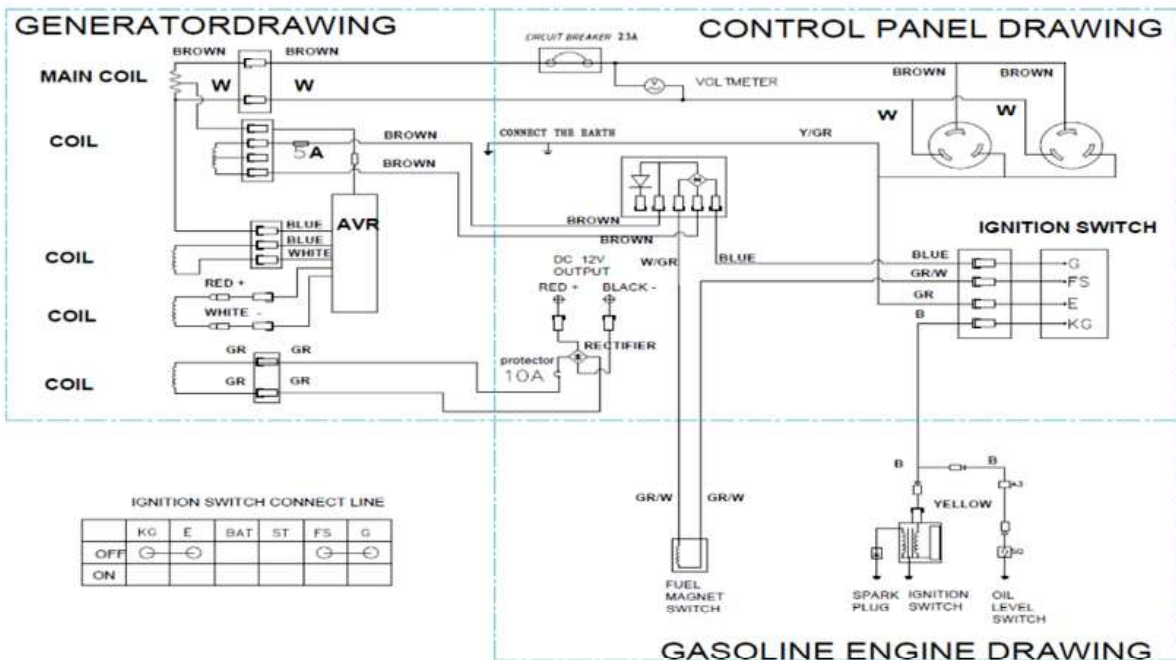

8.1 Warrantly

Warranty Terms and Conditions

1. This warranty shall enter into force on the date stated on the original purchase invoice and shall remain valid for a period of twelve (12) months.
2. This warranty is non-transferable unless prior written consent has been obtained from the supplier.
3. Warranty claims will not be accepted without presentation of the original purchase invoice.
4. This warranty shall apply exclusively provided that the product has been used in full compliance with the instructions contained in the user manual and solely for its intended purpose.
5. No alterations, modifications, or technical changes may be made to the product.
6. This warranty shall be void in the event of improper, negligent, or incorrect use of the product.
7. Transportation, shipping, and related costs are expressly excluded from this warranty.
8. Any repair work must be carried out exclusively by the supplier or an authorised service partner. Repairs performed by unauthorised third parties shall immediately void all warranty rights.
9. Repairs performed during the warranty period shall not result in an extension of the original warranty period. However, a separate warranty period of three (3) months shall apply to the repaired components, provided that the original warranty period has expired.
10. All maintenance and servicing operations described in the user manual must be performed in a timely and proper manner. Failure to do so may result in the warranty becoming void.
11. Warranty claims may only be submitted to the original point of sale at which the product was purchased.

8.2 EG-Verklaring

EG-verklaring van overeenstemming - Declaration of conformity – Konformitätsverklärung - Declaration de conformite - Dichiarazione di conformita- Declaracion de conformidad

Wij, Valkenpower BV, Haverkamp 11, 6051 AC Maasbracht, Nederland, verklaren geheel onder eigen verantwoordelijkheid dat de producten

We, Valkenpower BV, Haverkamp 11, 6051 AC Maasbracht, Nederland, declare under our sole responsibility that the receiver

Wir, Valkenpower BV, Haverkamp 11, 6051 AC Maasbracht, Nederland, erklären in alleiniger Verantwortung, daß der Behälter

Nous, Valkenpower BV, Haverkamp 11, 6051 AC Maasbracht, Nederland, déclarons sous notre seule responsabilité que le réservoir

Noi, Valkenpower BV, Haverkamp 11, 6051 AC Maasbracht, Nederland, dichiariamo sotto la nostra responsabilità che

La empresa, Valkenpower BV, Haverkamp 11, 6051 AC Maasbracht, Nederland, declara, bajo su responsabilidad, que

Type	Beschrijving	Merk
Model	Description	Brand
Art	Beschreibung	Marke
Tipe	Description	Marque
Tipo	Descrizione	Marca
Modelo	Descripción	Marca
EC7000NE	Generator	Valkenpower

Waarop deze verklaring betrekking heeft, in overeenstemming zijn met de volgende normen:

To which this declaration relates is in conformity with the following document:

Auf dem sich diese Erklärung bezieht, mit dem folgendem Dokument übereinstimmt:

Auquel se réfère cette déclaration est conforme à le document suivant:

A cui si riferisce dichiarazione, corrisponde ai seguenti documenti: Attestazione CE di tipo

Al que se refiere la presente declaración, corresponde a los siguientes documentos:

De machinerichtlijn: 2006/42/EG 2014/30/EU 2014/35/EU

Following the provisions of Directive: 2006/42/EG 2014/30/EU 2014/35/EU

Gemäß den Bestimmungen der Richtlinie: 2006/42/EG 2014/30/EU 2014/35/EU

Conformément aux dispositions de la Directive: 2006/42/EG 2014/30/EU 2014/35/EU

Conformemente alla direttiva: 2006/42/EG 2014/30/EU 2014/35/EU

Conforme con la norma: 2006/42/EG 2014/30/EU 2014/35/EU

Serienummer:
Serial number:

Directeur Valkenpower

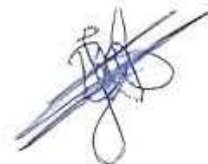

Nederland, Maasbracht, 11-04-2023

B.A.H Valkenburg